

**Description**

The LCEP0178A uses **Super Trench** technology that is uniquely optimized to provide the most efficient high frequency switching performance. Both conduction and switching power losses are minimized due to an extremely low combination of $R_{DS(on)}$ and Q_g . This device is ideal for high-frequency switching and synchronous rectification.

General Features

- $V_{DS} = 100V, I_D = 78A$
 $R_{DS(on)} = 7.2m\Omega$ (typical) @ $V_{GS} = 10V$
 $R_{DS(on)} = 9.5m\Omega$ (typical) @ $V_{GS} = 4.5V$
- Excellent gate charge x $R_{DS(on)}$ product (FOM)
- Very low on-resistance $R_{DS(on)}$
- 175 °C operating temperature
- Pb-free lead plating
- 100% UIS tested

Application

- DC/DC Converter
- Ideal for high-frequency switching and synchronous rectification

100% UIS TESTED!

100% ΔV_d s TESTED!

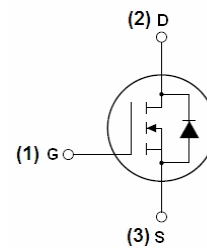

Schematic diagram

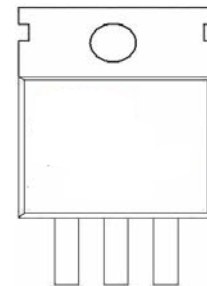

Marking and pin assignment

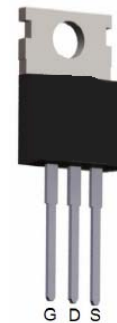

TO-220-3L top view

Package Marking and Ordering Information

Device Marking	Device	Device Package	Reel Size	Tape width	Quantity
NCEP0178A	LCEP0178A	TO-220-3L	-	-	-

Absolute Maximum Ratings ($T_C = 25^\circ\text{C}$ unless otherwise noted)

Parameter	Symbol	Limit	Unit
Drain-Source Voltage	V_{DS}	100	V
Gate-Source Voltage	V_{GS}	± 20	V
Drain Current-Continuous	I_D	78	A
Drain Current-Continuous ($T_C = 100^\circ\text{C}$)	$I_D(100^\circ\text{C})$	60	A
Pulsed Drain Current	I_{DM}	320	A
Maximum Power Dissipation	P_D	125	W
Derating factor		0.83	W/ $^\circ\text{C}$
Single pulse avalanche energy ^(Note 5)	E_{AS}	320	mJ
Operating Junction and Storage Temperature Range	T_J, T_{STG}	-55 To 175	$^\circ\text{C}$

**Thermal Characteristic**

Thermal Resistance, Junction-to-Case ^(Note 2)	$R_{\theta JC}$	1.2	$^{\circ}C/W$
--	-----------------	-----	---------------

Electrical Characteristics ($T_C=25^{\circ}C$ unless otherwise noted)

Parameter	Symbol	Condition	Min	Typ	Max	Unit
Off Characteristics						
Drain-Source Breakdown Voltage	BV_{DSS}	$V_{GS}=0V, I_D=250\mu A$	100		-	V
Zero Gate Voltage Drain Current	I_{DSS}	$V_{DS}=100V, V_{GS}=0V$	-	-	1	μA
Gate-Body Leakage Current	I_{GSS}	$V_{GS}=\pm 20V, V_{DS}=0V$	-	-	± 100	nA
On Characteristics ^(Note 3)						
Gate Threshold Voltage	$V_{GS(th)}$	$V_{DS}=V_{GS}, I_D=250\mu A$	1.2	1.7	2.2	V
Drain-Source On-State Resistance	$R_{DS(on)}$	$V_{GS}=10V, I_D=39A$	-	7.2	8.5	m Ω
		$V_{GS}=4.5V, I_D=39A$	-	9.5	12	m Ω
Forward Transconductance	g_{FS}	$V_{DS}=10V, I_D=39A$	40	-	-	S
Dynamic Characteristics ^(Note 4)						
Input Capacitance	C_{iss}	$V_{DS}=50V, V_{GS}=0V,$ $F=1.0MHz$	-	4200	5480	PF
Output Capacitance	C_{oss}		-	354	425	PF
Reverse Transfer Capacitance	C_{rss}		-	23	30	PF
Switching Characteristics ^(Note 4)						
Turn-on Delay Time	$t_{d(on)}$	$V_{DD}=50V, I_D=39A$ $V_{GS}=10V, R_G=4.7\Omega$	-	15	-	nS
Turn-on Rise Time	t_r		-	10	-	nS
Turn-Off Delay Time	$t_{d(off)}$		-	41	-	nS
Turn-Off Fall Time	t_f		-	6	-	nS
Total Gate Charge	Q_g	$V_{DS}=50V, I_D=39A,$ $V_{GS}=10V$	-	65		nC
Gate-Source Charge	Q_{gs}		-	15.3		nC
Gate-Drain Charge	Q_{gd}		-	9		nC
Drain-Source Diode Characteristics						
Diode Forward Voltage ^(Note 3)	V_{SD}	$V_{GS}=0V, I_S=78A$	-		1.2	V
Diode Forward Current ^(Note 2)	I_S		-	-	78	A
Reverse Recovery Time	t_{rr}	$T_J = 25^{\circ}C, I_F = I_S$	-	101		nS
Reverse Recovery Charge	Q_{rr}	$di/dt = 100A/\mu s$ ^(Note 3)	-	193		nC

Notes:

1. Repetitive Rating: Pulse width limited by maximum junction temperature.
2. Surface Mounted on FR4 Board, $t \leq 10$ sec.
3. Pulse Test: Pulse Width $\leq 300\mu s$, Duty Cycle $\leq 2\%$.
4. Guaranteed by design, not subject to production
5. EAS condition : $T_J=25^{\circ}C, V_{DD}=50V, V_G=10V, L=0.5mH, R_g=25\Omega$

Test Circuit

1) E_{AS} test Circuit



2) Gate charge test Circuit

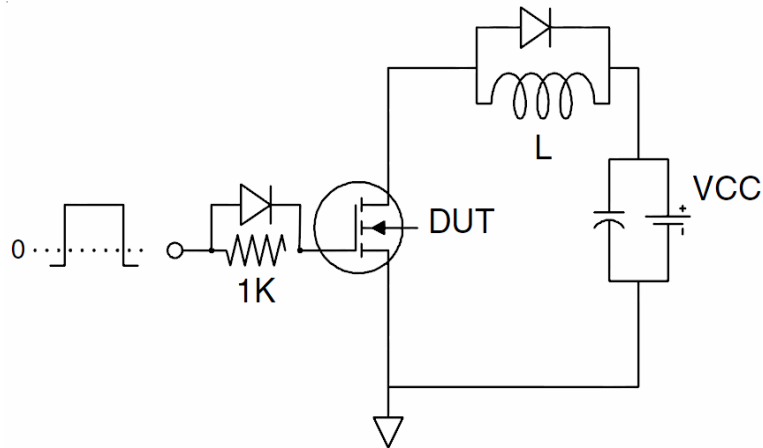

3) Switch Time Test Circuit





Typical Electrical and Thermal Characteristics

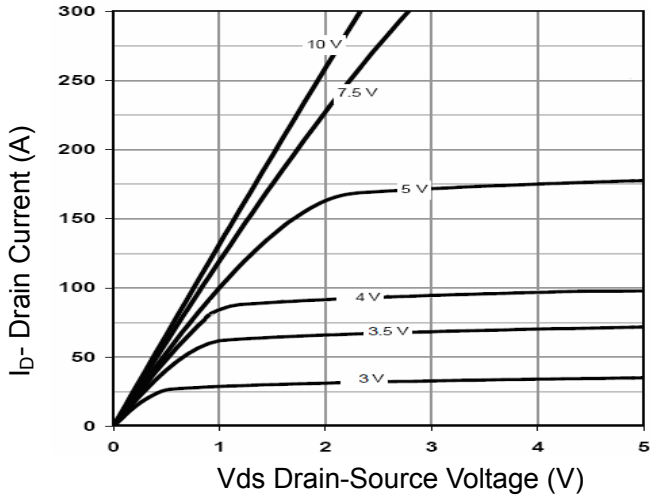

Figure 1 Output Characteristics

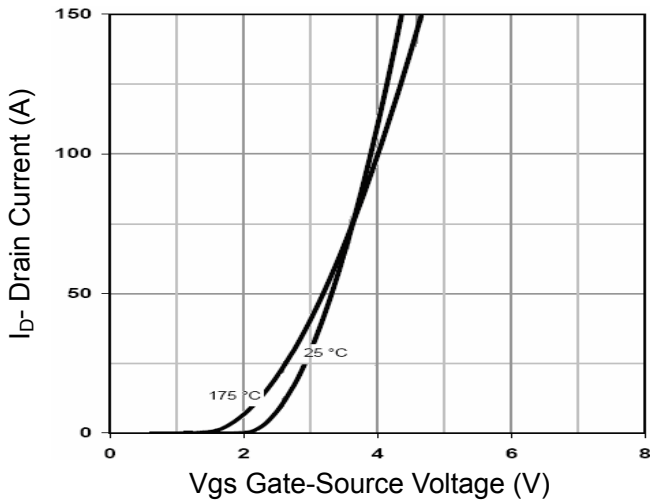

Figure 2 Transfer Characteristics

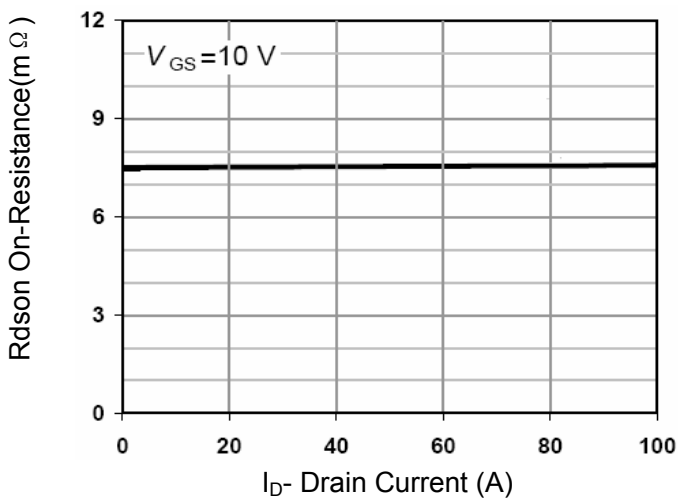

Figure 3 Rdson- Drain Current

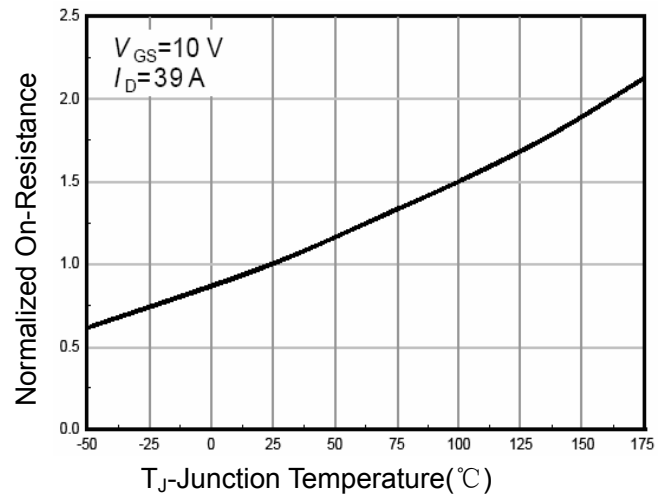

Figure 4 Rdson-Junction Temperature

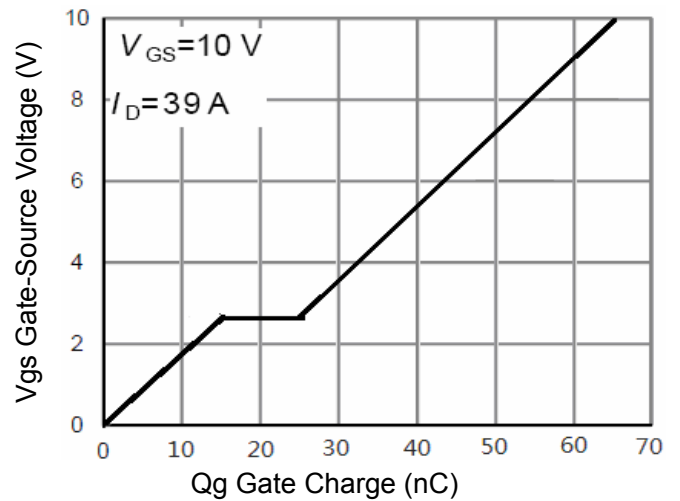

Figure 5 Gate Charge

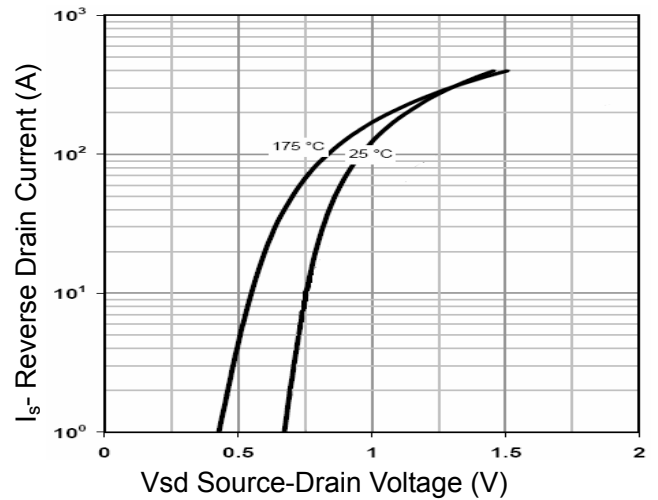

Figure 6 Source- Drain Diode Forward

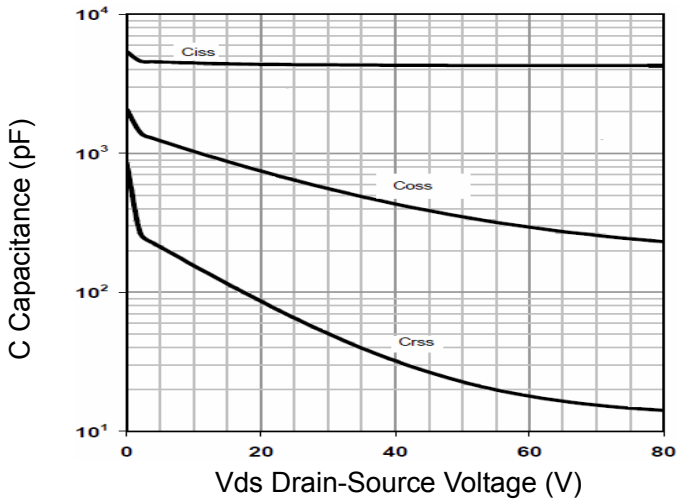

Figure 7 Capacitance vs Vds

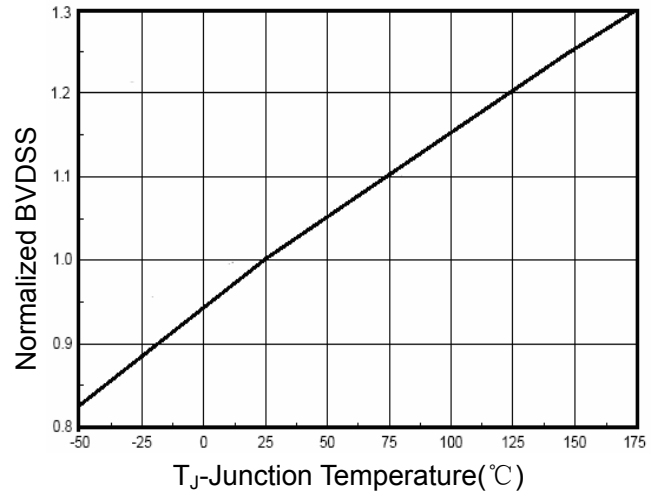

Figure 9 BV_{DSS} vs Junction Temperature

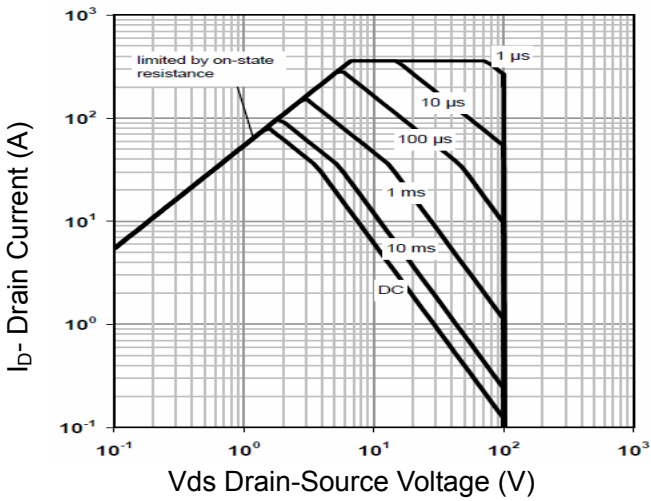

Figure 8 Safe Operation Area

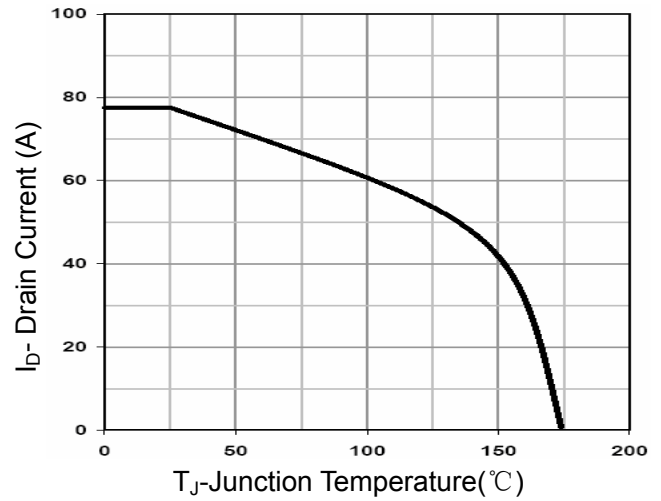

Figure 10 Current De-rating

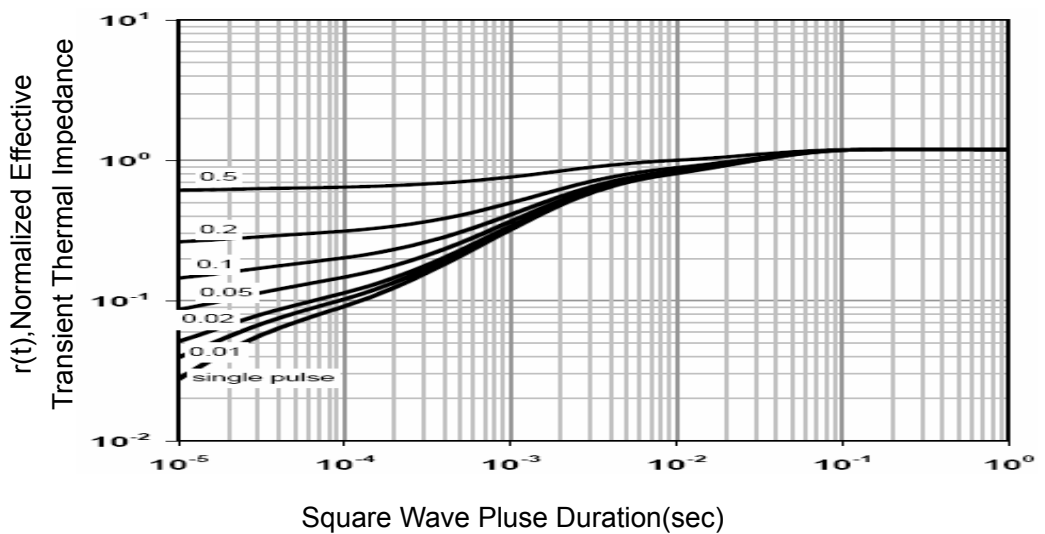
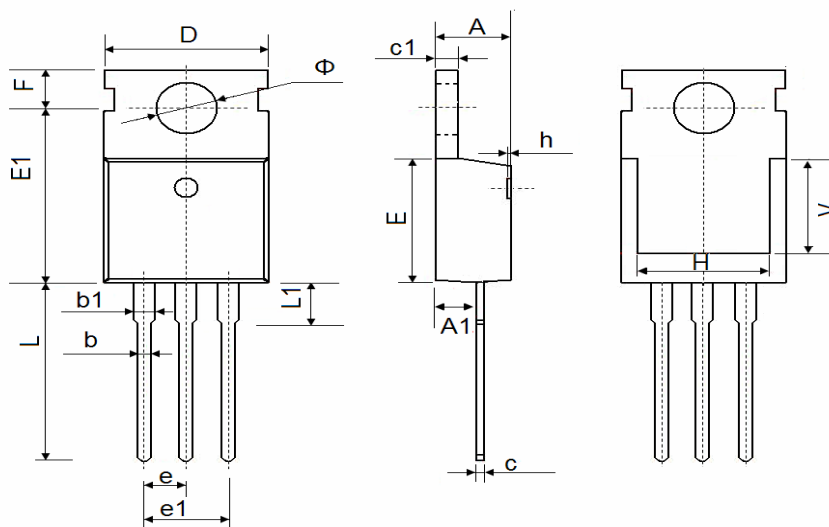

Figure 11 Normalized Maximum Transient Thermal Impedance



TO-220-3L Package Information



Symbol	Dimensions In Millimeters		Dimensions In Inches	
	Min.	Max.	Min.	Max.
A	4.400	4.600	0.173	0.181
A1	2.250	2.550	0.089	0.100
b	0.710	0.910	0.028	0.036
b1	1.170	1.370	0.046	0.054
c	0.330	0.650	0.013	0.026
c1	1.200	1.400	0.047	0.055
D	9.910	10.250	0.390	0.404
E	8.9500	9.750	0.352	0.384
E1	12.650	12.950	0.498	0.510
e	2.540 TYP.		0.100 TYP.	
e1	4.980	5.180	0.196	0.204
F	2.650	2.950	0.104	0.116
H	7.900	8.100	0.311	0.319
h	0.000	0.300	0.000	0.012
L	12.900	13.400	0.508	0.528
L1	2.850	3.250	0.112	0.128
V	7.540 REF.		0.295 REF.	
Φ	3.400	3.800	0.134	0.150

Shanghai Leiditech Electronic Co.,Ltd
 Email: sale1@leiditech.com
 Tel : +86- 021 50828806
 Fax : +86- 021 50477059