

### Features

- Ultra low capacitance: 0.6pF typical
- Ultra low leakage: nA level
- Operating voltage: 3.3V
- Low clamping voltage
- Complies with following standards:
  - IEC 61000-4-2 (ESD) immunity test
    - Air discharge:  $\pm 25\text{kV}$
    - Contact discharge:  $\pm 20\text{kV}$
  - IEC61000-4-5 (Lightning) 6A (8/20 $\mu\text{s}$ )
- RoHS Compliant

### Dimensions SOD-523



### Applications

- Cellular Handsets and Accessories
- Display Ports
- MDDI Ports
- USB Ports
- Digital Visual Interface (DVI)
- PCI Express and Serial SATA Ports

### Pin Configuration

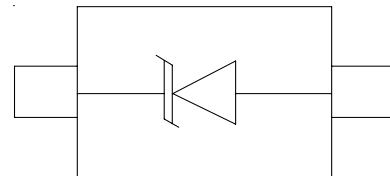

### Mechanical Characteristics

- Package: SOD-523
- Lead Finish: Lead Free
- UL Flammability Classification Rating 94V-0
- Quantity Per Reel: 3,000pcs
- Reel Size: 7 inch

### Absolute Maximum Ratings (T<sub>amb</sub>=25°C unless otherwise specified)

Parameter	Symbol	Value	Unit
Peak Pulse Power (8/20 $\mu\text{s}$ )	P <sub>pp</sub>	100	W
ESD per IEC 61000-4-2 (Air)	V <sub>ESD</sub>	$\pm 25$	Kv
ESD per IEC 61000-4-2 (Contact)		$\pm 20$	
Operating Temperature Range	T <sub>J</sub>	-55 to +125	°C
Storage Temperature Range	T <sub>STJ</sub>	-55 to +150	°C

## Electrical Characteristics (TA=25°C unless otherwise specified)

Part Number	Device Marking	V <sub>RWM</sub> (V)	V <sub>BR</sub> (V)	I <sub>T</sub> (mA)	V <sub>C</sub> @1A	V <sub>C</sub>		I <sub>R</sub> μA (Max)	C (Pf) (Typ.)
						(Max)	(@A)		
ESD5Z3L	36	3.3	4.2	1	9	16	6	0.2	0.6

## Typical Performance Characteristics (TA=25°C unless otherwise Specified)

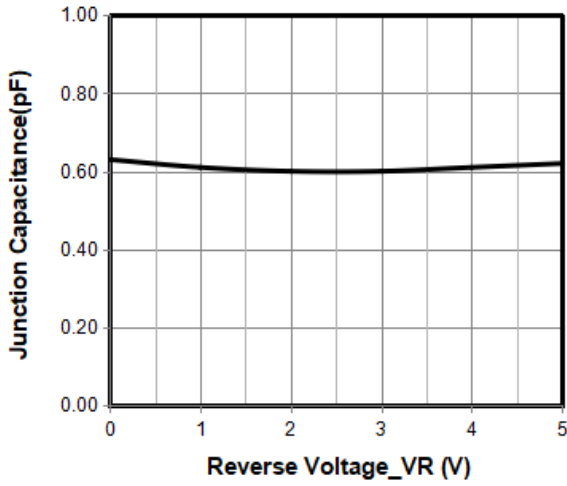

Junction Capacitance vs. Reverse Voltage

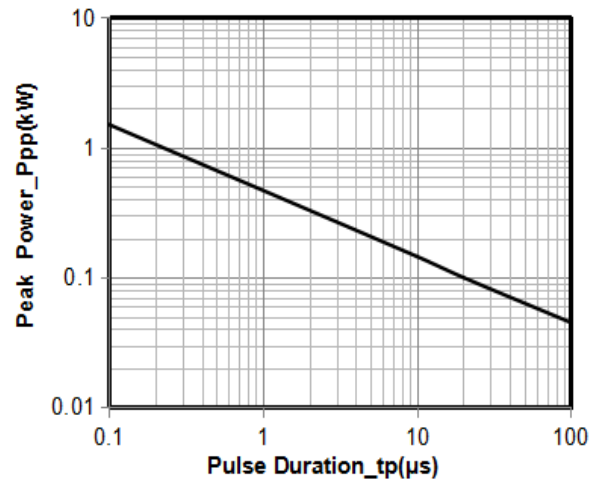

Peak Pulse Power vs. Pulse Time

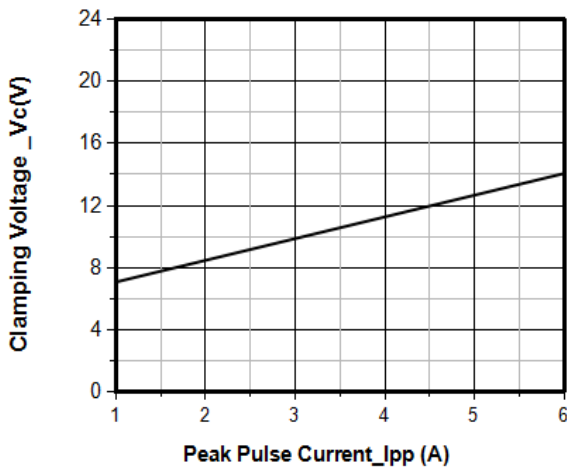

Clamping Voltage vs. Peak Pulse Current

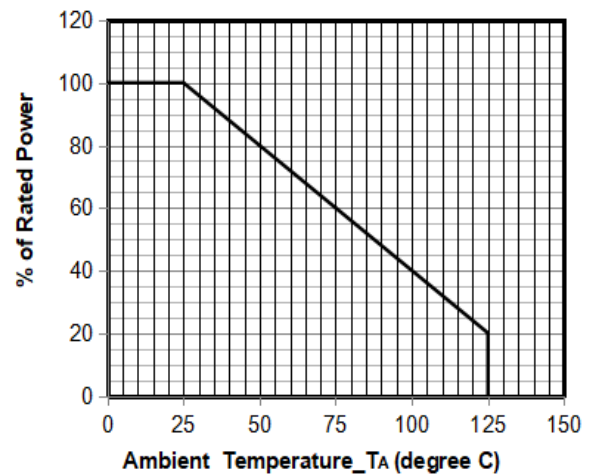

Power Derating Curve

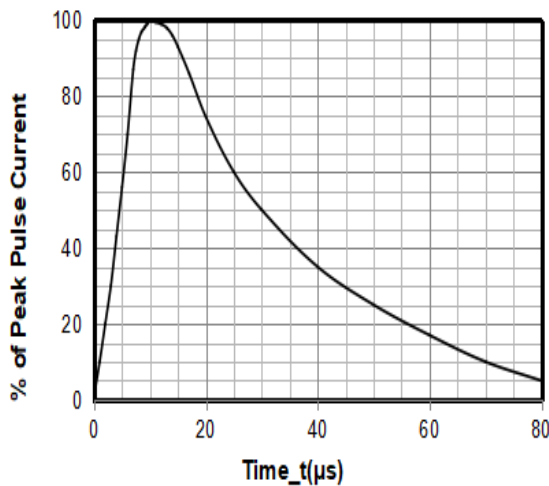

8 X 20μs Pulse Waveform

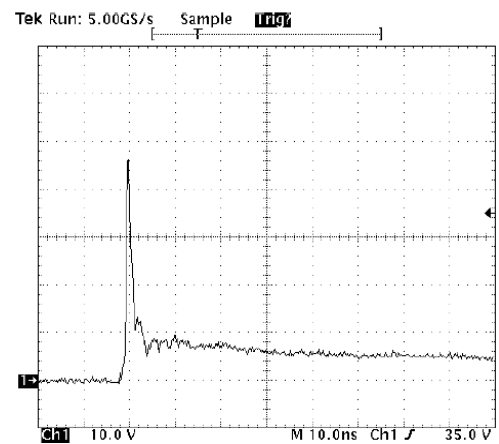

Note: Data is taken with a 10x attenuator

ESD Clamping Voltage

8 kV Contact per IEC61000-4-2

## SOD-523 Package Outline & Dimensions

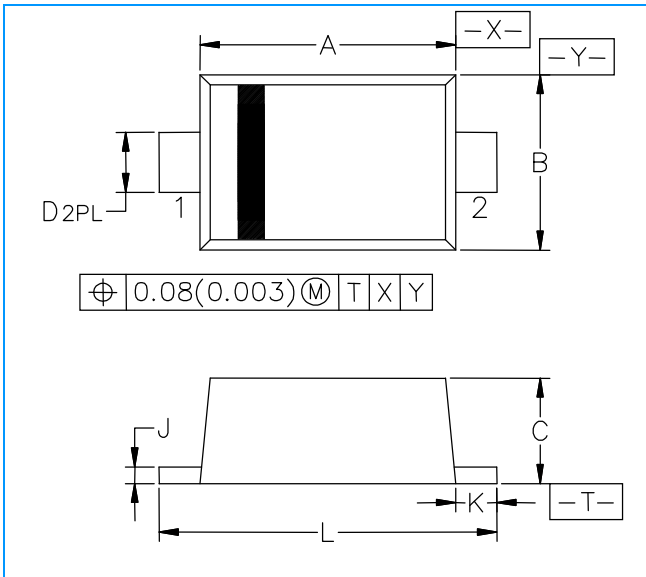

Symbol	Millimeters			Inches		
	Min.	Nom.	Max.	Min.	Nom.	Max.
<b>A</b>	1.10	1.20	1.30	0.043	0.047	0.051
<b>B</b>	0.70	0.80	0.90	0.028	0.032	0.035
<b>C</b>	0.50	0.60	0.70	0.020	0.024	0.028
<b>D</b>	0.25	0.30	0.35	0.010	0.012	0.014
<b>J</b>	0.07	0.14	0.20	0.0028	0.0055	0.0079
<b>K</b>	0.15	0.20	0.25	0.006	0.008	0.010
<b>L</b>	1.50	1.60	1.70	0.059	0.063	0.067

### Soldering Footprint

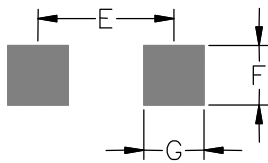

Symbol	Millimeters	Inches
<b>E</b>	1.40	0.0547
<b>F</b>	0.40	0.0157
<b>G</b>	0.40	0.0157