

Description

The LMAK50P10 uses advanced trench technology to provide excellent $R_{DS(ON)}$, low gate charge and operation with gate voltages as low as 4.5V. This device is suitable for use as a Battery protection or in other Switching application.

Dimensions TO-252

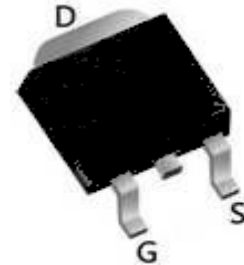

General Features

$V_{DS} = -100V$ $I_D = -50A$

$R_{DS(ON)} < 52m\Omega$ @ $V_{GS}=10V$ (Typ. 40m Ω)

Application

- Brushless motor
- Load switch
- Uninterruptible power supply

Pin Configuration

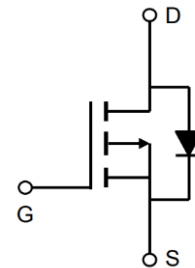

Package Marking and Ordering Information

Device	Device Marking	Device Package	Reel Size	Tape width	Quantity
LMAK50P10	AP50P10D	TO-252	-	-	2500 units

Absolute Maximum Ratings (TC=25°C unless otherwise noted)

Symbol	Parameter	Rating	Units
V_{DS}	Drain-Source Voltage	-100	V
V_{GS}	Gate-Source Voltage	± 20	V
$I_D@T_C=25^\circ C$	Continuous Drain Current, V_{GS} @ -10V ¹	-50	A
$I_D@T_C=100^\circ C$	Continuous Drain Current, V_{GS} @ -10V ¹	-28	A
I_{DM}	Pulsed Drain Current ²	-150	A
EAS	Single Pulse Avalanche Energy ³	87	mJ
I_{AS}	Avalanche Current	-35	A
$P_D@T_C=25^\circ C$	Total Power Dissipation ⁴	140	W
T_{STG}	Storage Temperature Range	-55 to 150	°C
T_J	Operating Junction Temperature Range	-55 to 150	°C
$R_{\theta JA}$	Thermal Resistance Junction-Ambient ¹	62.5	°C/W
$R_{\theta JC}$	Thermal Resistance Junction-Case ¹	1.1	°C/W

Electrical Characteristics (T_J=25°C, unless otherwise noted)

Symbol	Parameter	Test Condition	Min.	Typ.	Max.	Units
V(BR)DSS	Drain-Source Breakdown Voltage	V _{GS} =0V, I _D =-250μA	-100	-	-	V
IDSS	Zero Gate Voltage Drain Current	V _{DS} =-100V, V _{GS} =0V,	-	-	-1.0	μA
IGSS	Gate to Body Leakage Current	V _{DS} =0V, V _{GS} = ±20V	-	-	±100	nA
VGS(th)	Gate Threshold Voltage	V _{DS} =V _{GS} , I _D =-250μA	-1.0	-1.6	-2.5	V
RDS(on)	Static Drain-Source on-Resistance	V _{GS} =-10V, I _D =-20A	-	40	52	mΩ
		V _{GS} =-4.5V, I _D =-10A	-	44	62	
Ciss	Input Capacitance	V _{DS} =-50V, V _{GS} =0V, f=1.0MHz	-	2120	-	pF
Coss	Output Capacitance		-	194	-	pF
Crss	Reverse Transfer Capacitance		-	13	-	pF
Q _g	Total Gate Charge	V _{DS} =-50V, I _D =-5A, V _{GS} =-10V	-	40	-	nC
Q _{gs}	Gate-Source Charge		-	7.8	-	nC
Q _{gd}	Gate-Drain("Miller") Charge		-	8.6	-	nC
td(on)	Turn-on Delay Time	V _{DD} =-50V, I _D =-5A, R _G =6Ω, V _{GS} =-10V	-	13	-	ns
t _r	Turn-on Rise Time		-	39	-	ns
td(off)	Turn-off Delay Time		-	100.1	-	ns
t _f	Turn-off Fall Time		-	105.3	-	ns
IS	Maximum Continuous Drain to Source Diode Forward Current		-	-	-35	A
ISM	Maximum Pulsed Drain to Source Diode Forward Current		-	-	-140	A
VSD	Drain to Source Diode Forward Voltage	V _{GS} =0V, I _S =-30A	-	-	-1.2	V
t _{rr}	Body Diode Reverse Recovery Time	T _J =25°C, I _F =-5A, dI/dt=100A/μs	-	104	-	ns
Q _{rr}	Body Diode Reverse Recovery Charge		-	280	-	nC

Note :

- 1、 The data tested by surface mounted on a 1 inch 2 FR-4 board with 2OZ copper.
- 2、 The data tested by pulsed , pulse width ≅ 300us , duty cycle ≅ 2%
- 3、 The EAS data shows Max. rating . The test condition is V_{DD} =-25V, V_{GS} =-10V, L=0.1mH, I_{AS} =-24A
- 4、 The power dissipation is limited by 150°C junction temperature
- 5、 The data is theoretically the same as I_D and I_{DM} , in real applications , should be limited by total power dissipation.

Typical Characteristics

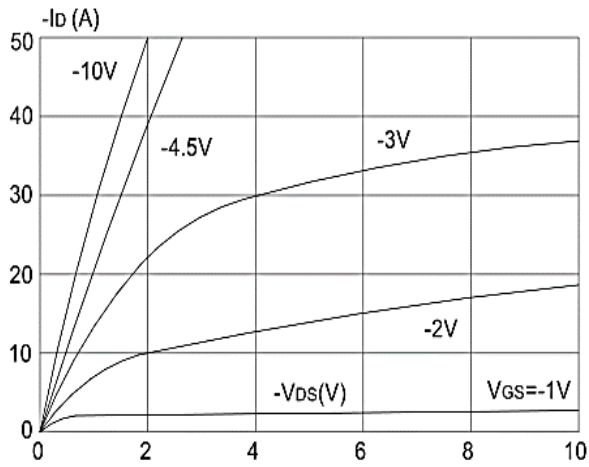

Figure 1: Output Characteristics

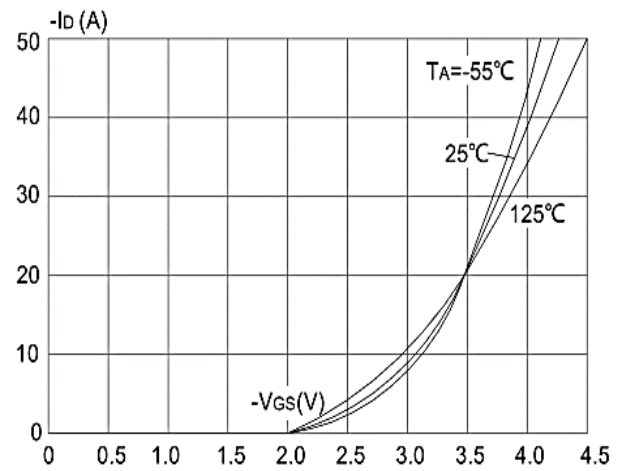

Figure 2: Typical Transfer Characteristics

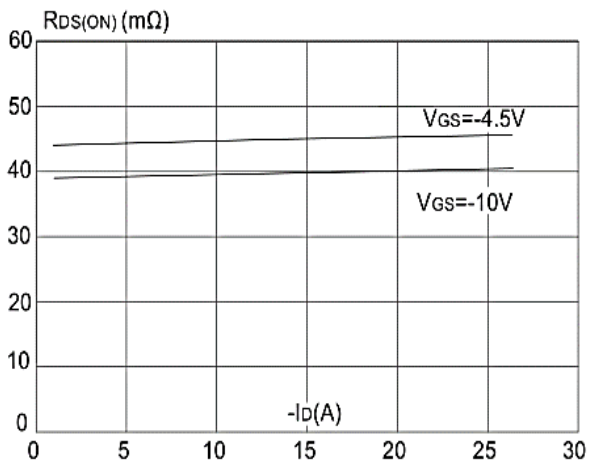

Figure 3: On-resistance vs. Drain Current

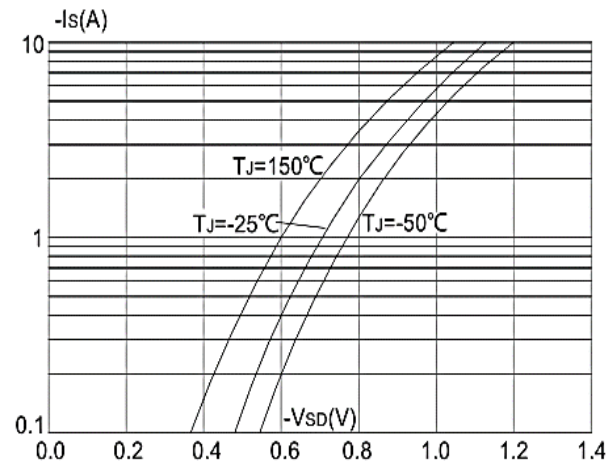

Figure 4: Body Diode Characteristics

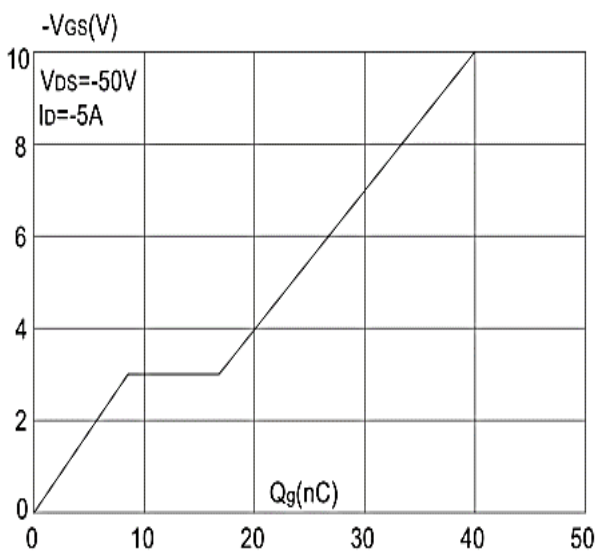

Figure 5: Gate Charge Characteristics

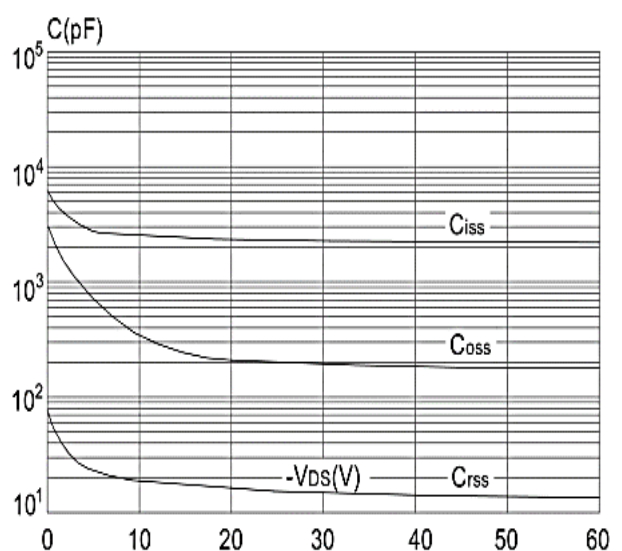

Figure 6: Capacitance Characteristics

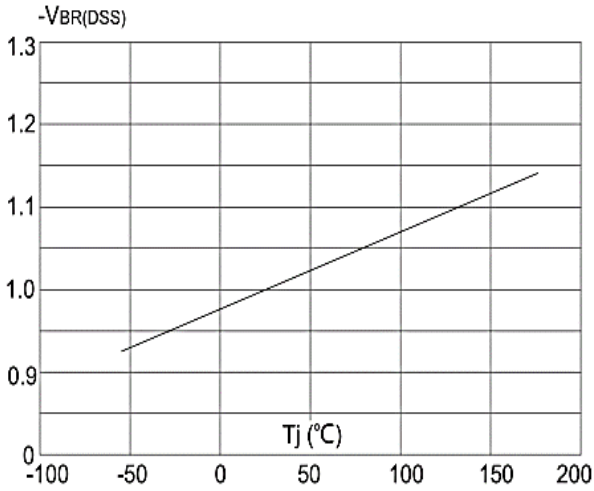

Figure 7: Normalized Breakdown Voltage vs Junction Temperature

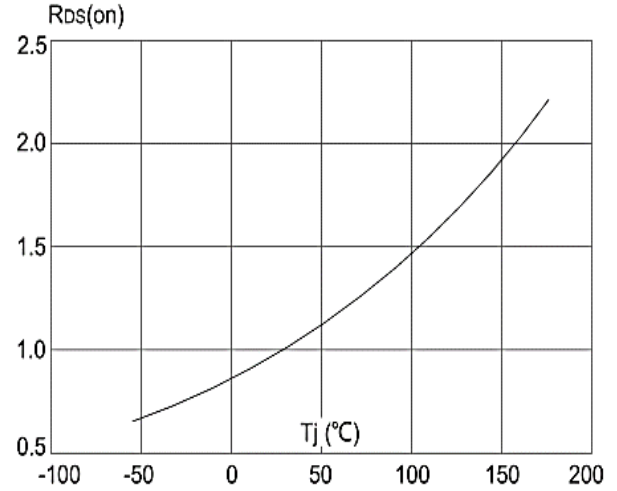

Figure 8: Normalized on Resistance vs. Junction Temperature

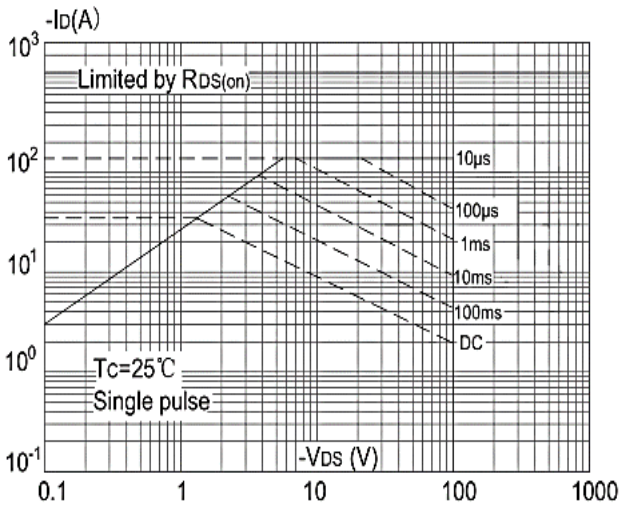

Figure 9: Maximum Safe Operating Area

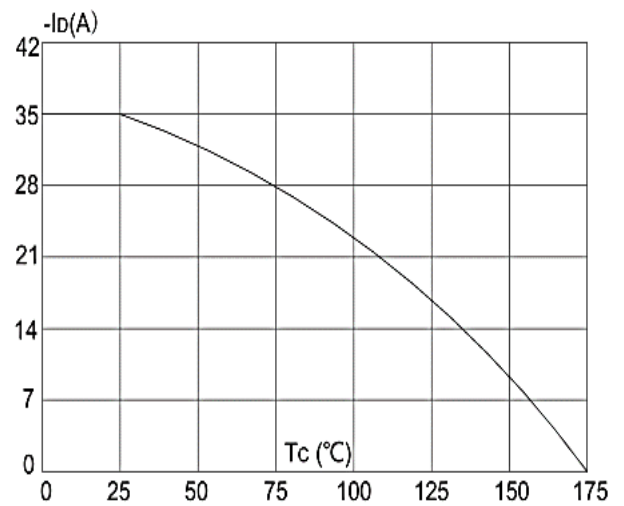

Figure 10: Maximum Continuous Drain Current vs. Ambient Temperature

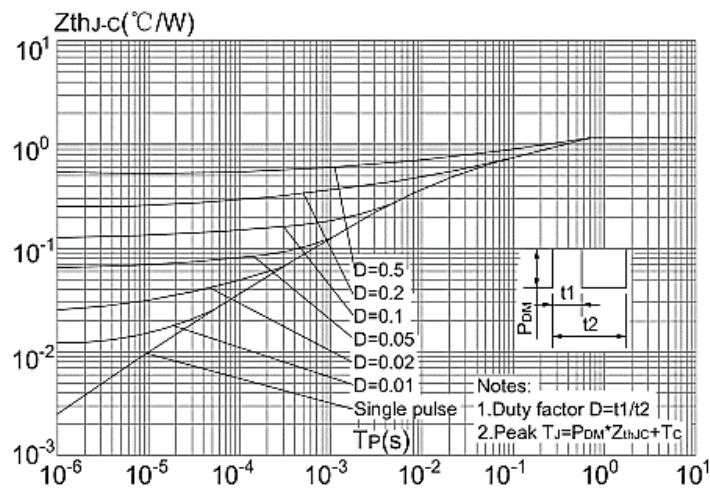
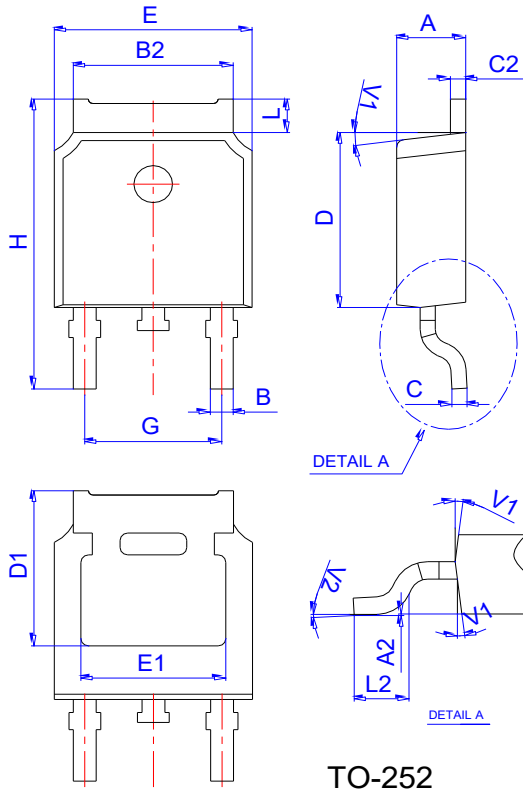

Figure.11: Maximum Effective Transient Thermal Impedance, Junction-to-Ambien

Package Mechanical Data



Ref.	Dimensions					
	Millimeters			Inches		
	Min.	Typ.	Max.	Min.	Typ.	Max.
A	2.10		2.50	0.083		0.098
A2	0		0.10	0		0.004
B	0.66		0.86	0.026		0.034
B2	5.18		5.48	0.202		0.216
C	0.40		0.60	0.016		0.024
C2	0.44		0.58	0.017		0.023
D	5.90		6.30	0.232		0.248
D1	5.30REF			0.209REF		
E	6.40		6.80	0.252		0.268
E1	4.63			0.182		
G	4.47		4.67	0.176		0.184
H	9.50		10.70	0.374		0.421
L	1.09		1.21	0.043		0.048
L2	1.35		1.65	0.053		0.065
V1		7°			7°	
V2	0°		6°	0°		6°

Reel Specification-TO-252

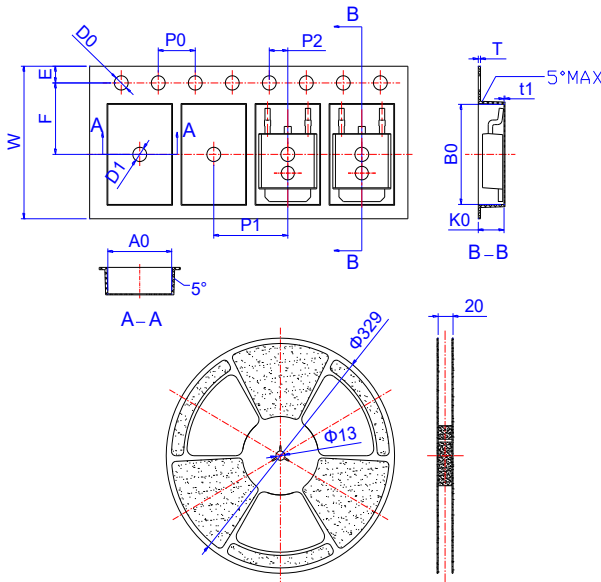

Ref.	Dimensions					
	Millimeters			Inches		
	Min.	Typ.	Max.	Min.	Typ.	Max.
W	15.90	16.00	16.10	0.626	0.630	0.634
E	1.65	1.75	1.85	0.065	0.069	0.073
F	7.40	7.50	7.60	0.291	0.295	0.299
D0	1.40	1.50	1.60	0.055	0.059	0.063
D1	1.40	1.50	1.60	0.055	0.059	0.063
P0	3.90	4.00	4.10	0.154	0.157	0.161
P1	7.90	8.00	8.10	0.311	0.315	0.319
P2	1.90	2.00	2.10	0.075	0.079	0.083
A0	6.85	6.90	7.00	0.270	0.271	0.276
B0	10.45	10.50	10.60	0.411	0.413	0.417
K0	2.68	2.78	2.88	0.105	0.109	0.113
T	0.24		0.27	0.009		0.011
t1	0.10			0.004		
10P0	39.80	40.00	40.20	1.567	1.575	1.583